

Aluminium Decking System

Aluminium decking systems for waterproofed substrates

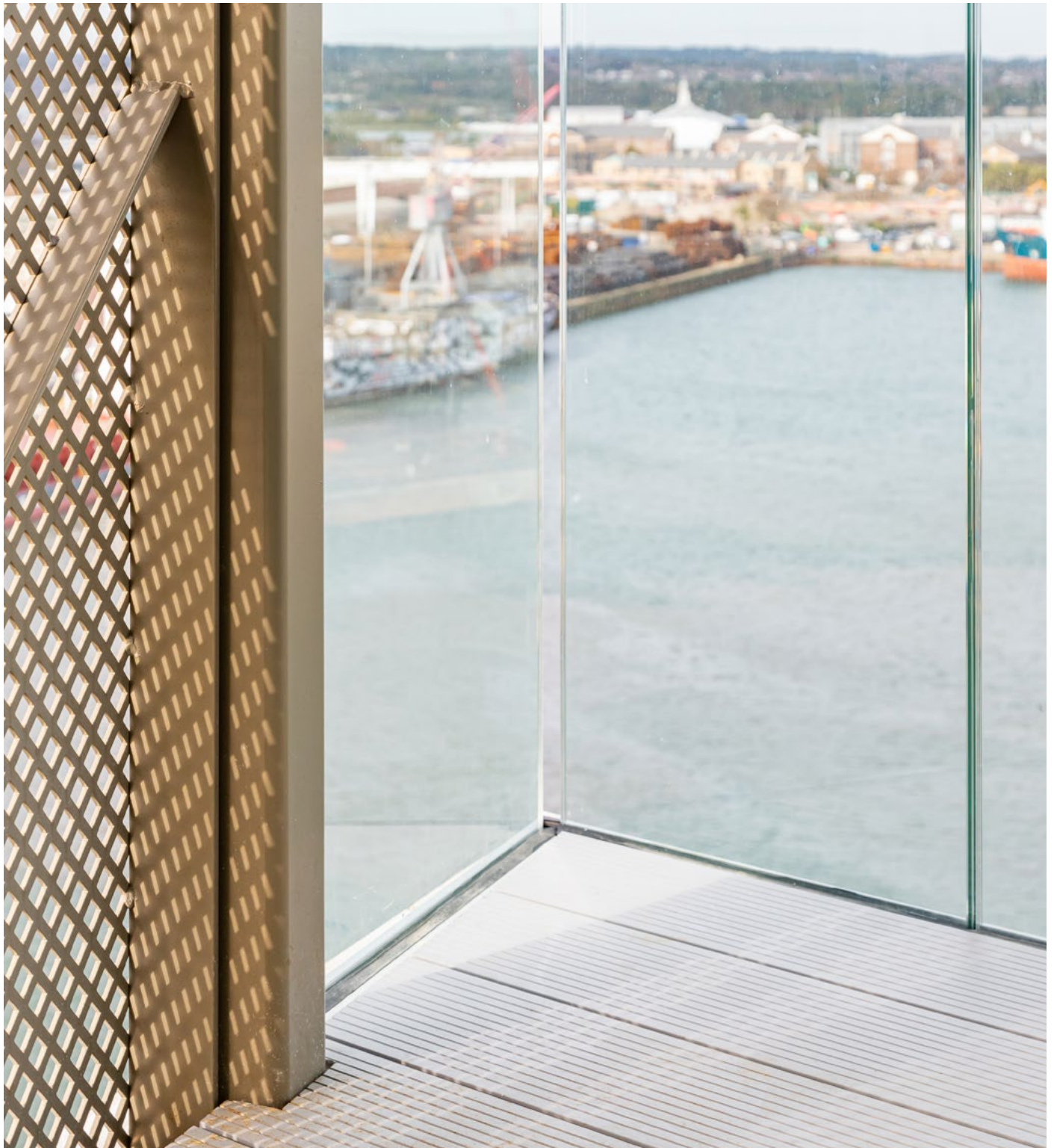



Why this System?

TerraSmart™ Aluminium is a non-combustible aluminium decking system designed to be installed on waterproofed balconies, terraces, and roofs. A broad range of decking board and component combinations are available to achieve the designed finish, height build-up and performance standard.

“Non-combustible... decking”

- 30-year warranty, 60-year design life
Achieves Euroclass A2-s1,d0 to EN 13501-1:2018
- Ideal for terraces, podiums, and waterproofed/inset/concrete balconies
- Suited to large scale, high-rise remediation, new build, and refurbishment projects
- All boards available in standard range of six RAL colours (any RAL colour available on additional lead time)
- Long-lasting, with excellent scratch and wear resistance
- Slip-resistant to BS 7976-2:2002



Out of the Box Compliance

Like you, we want to make our buildings and our lives safer. So we've made it easy for you to comply with current building and fire safety regulations. You choose the finish, we'll take care of the compliance. Simple, smart, non-combustible flooring systems for terraces and balconies

System Overview

1. Composite Decking

The classic TerraSmart Aluminium decking board is premium quality, highly dent resistance and features a slip-resistant finish that boasts excellent scratch-resistance and durability. Best of all no maintenance is required

2. Joist Pedestal

Non-combustible adjustable height joist pedestal, available in a range of height build-ups and compatible with our ADS joists.

3. Fixing Clips

Decking boards are secured in place with our hidden fixing system, including our patent-pending AluClip™ (patent no: GB2009927.1) which fixes boards via clamp mechanism, allowing thermal expansion and contraction of boards.

4. Aluminium Joist

Our aluminium decking joists are available in three joist depths, to suit different span requirements.

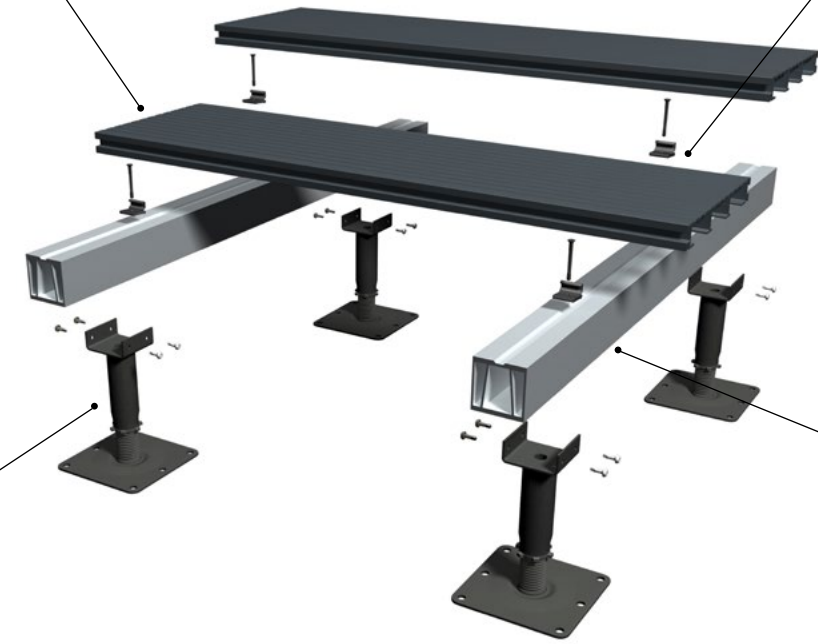

Technical Specification

Fire rating (to EN13501-1)	A2-s1,d0
Height range	48-615mm
Loading/compression	Concentrated/point load: 2kN Uniformly distributed: >4.0kN/m2
Warranty	30 years*
Design Life	60 years*

*Valid when used as part of a complete RYNO IGNO system

System Build Up

Smaller solutions are available contact us for more information

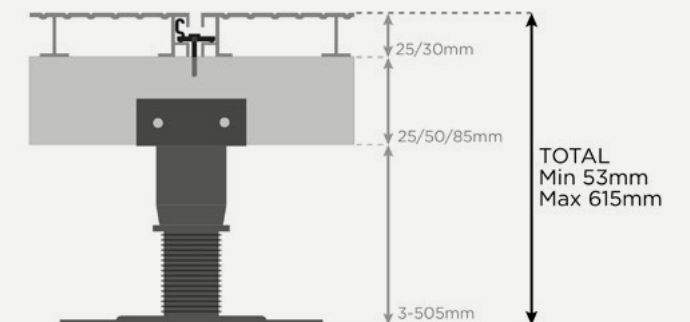

Finishes

Aluminium Range

Powder coated with a textured coating for high slip resistance available in a select range of standard colours.



Anthracite Grey: RAL 7016

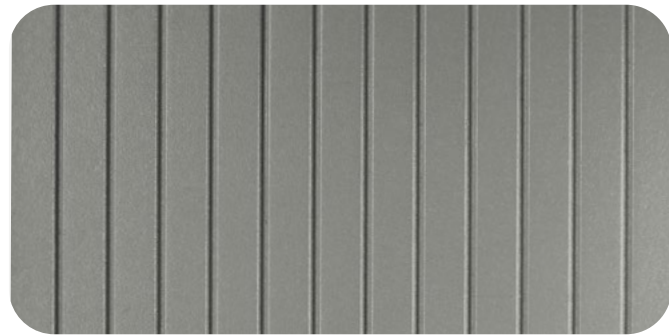

Dust Grey: RAL 7037



Grey Brown: RAL 8019



Quartz Grey: RAL 7039



Sepia Brown: RAL 8014



Window Grey: RAL 7040

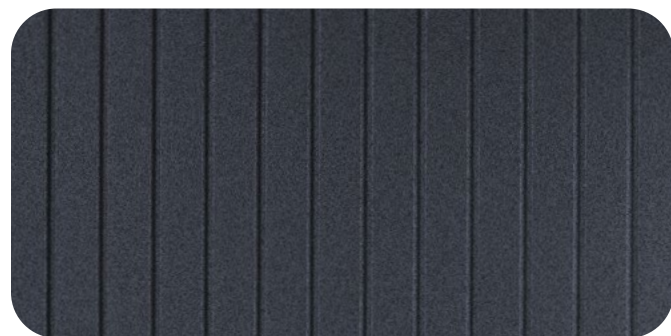

Ultra Grip™: RAL 7016

Ultra Grip™

For enhanced slip resistance and surface durability, our UltraGrip™ finish can be used as part of the TerraSmart™ Aluminium system.



Options

Joist Pedestal

Our fully non-combustible steel joist pedestal enables an easy install. Available to suit large build-up requirements it's height can be quickly and simply adjusted to 505mm. The pedestal is protected from corrosion with zinc-nickel electroplating.



Low-height Support Cleat

For use where very little height build-up is available. Joist cleats are height adjustable, catering for falls, or to meet door thresholds while contributing as little as 3mm build-up. Manufactured from high-quality aluminium, with a wide base for spreading weight evenly.



Joist

Manufactured from strong and lightweight aluminium the joist provides the optimal level of support for decking boards and is available in mill finish or powder coated.



AluClip™

The simplest, quickest solution to hide mill-finished silver aluminium joists; the wide AluClip™. Rather than the additional cost of powder coating the joists, the black clip simply covers over any exposed joist which would have been visible through the gaps



Options

Multiple Board Spans

When install times are tight, larger span boards can be chosen to speed up the installation process. Larger span boards reduce the amount of substructure required, maximising efficiency and limiting costs. TerraSmart aluminium decking boards are available in a variety of different spans, providing the ultimate range depending on whether the driving factor is either material cost, or install time.

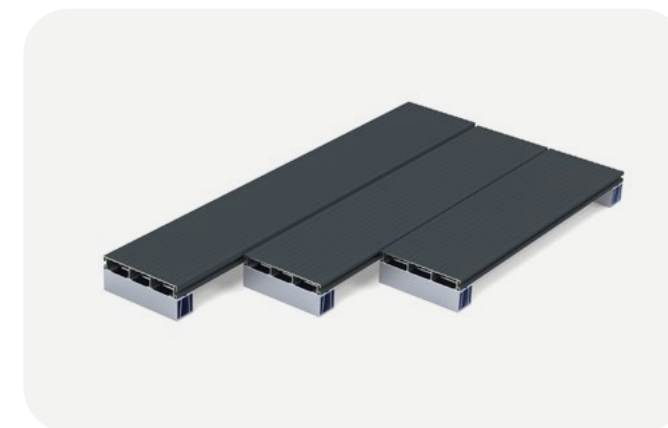

Termination Profile

Termination profiles are a great addition where that extra finesse is required to the edges of the deck area. They are installed at board edges and ends, concealing any cut edges and offering a very neat finish with a small trim visible from the top of the decking.

Profiles are manufactured from aluminium and are powder coated to match the decking boards.



Furniture Anchor

The furniture anchor effectively secures outdoor furniture to prevent wind uplift and movement, as per guidance given in BS 8579:2020.

It takes seconds to install, simply slotting in between the aluminium decking boards. It works with all Ryno aluminium decking boards and can be removed and replaced easily



Spreader Plate

For applications where the substrate requires lower point pressure, the 170mm circular spreader plate can be attached to the underside of the pedestal base



Inspiration for your project

Chatham Waters Deckbuilders

Chatham Waters is a large development of 199 luxury apartments in Kent, with far-reaching views over the historic Chatham Docks.

Each of the 199 homes features its own large balcony space with Euroclass fire-rated aluminium decking and porcelain paving used interchangeably throughout the scheme to provide zoning and interest.

The contrasting external flooring is mirrored in the intermittent placement of the brass screening throughout the buildings in the scheme, providing a distinctive and luxurious appearance.

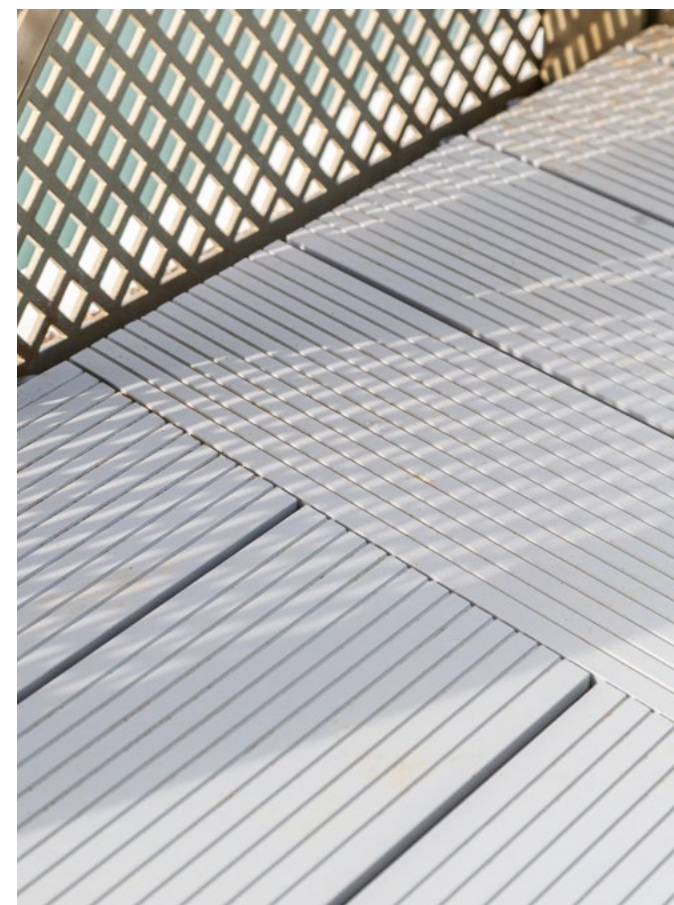

We make it easy

Inspiration

Did you flick through this brochure finding yourself thinking about a specific project? Well, we can help you out! Give our specification team a no-obligation, quick call today to answer any burning questions you might have, and find out if this is the system for you.

Design

Our specification team are invested in your success first and foremost. If you tell them what you want, they will find a way to make it possible. When you keep up with them during a project, they focus on finding you bespoke solutions to keep costs down and keep the project safe.

Support

We don't just ship your system and then send you on your way! We want to make sure that you are supported wherever and whenever you might need it. We know that things can change at the flick of a switch, so whatever you need, our project delivery team are here to help.

Finish

Once all is said and done, drop in past The Studio in Clerkenwell for a friendly smile and a good cup of coffee, or get yourself booked in for a RIBA-certified CPD to keep up-to-date with the changing landscape of balconies and terrace compliance



View the rest of the **TerraSmart®** range



TerraSmart®

Rail Paving System

Premium, versatile paving system
for waterproofed substrates



TerraSmart®

Pedestal Paving System

Straightforward, robust paving
system for waterproofed substrates



TerraSmart®

Vitrified Composite® Decking System

A1 fire-rated, wood effect decking
systems for waterproofed substrates

TerraSmart®

Composite Decking System

Wood-plastic composite decking
system for outdoor spaces

TerraSmart®

Pedestal Paving System

Straightforward, robust paving system
for waterproofed substrates, **where
non-combustibility isn't required**

TerraSmart®

Rail Paving System

Premium, versatile paving system
for waterproofed substrates, **where
non-combustibility isn't required**